

PART: EDT10-L2W45V

10" Wide Aluminum Truss. 2" Chords with 1/2" Webs

©2015 EXHIBIT AND DISPLAY TRUSS.COM

2 Way 45° Junction Vertical

Truss Profile

10" Wide Ladder Truss (Vertical)
2"Ø Chords, 1/2"Ø Webs

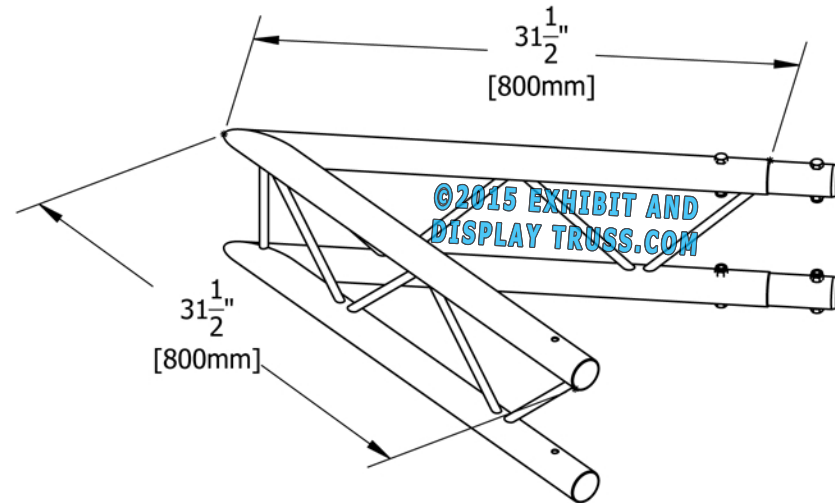
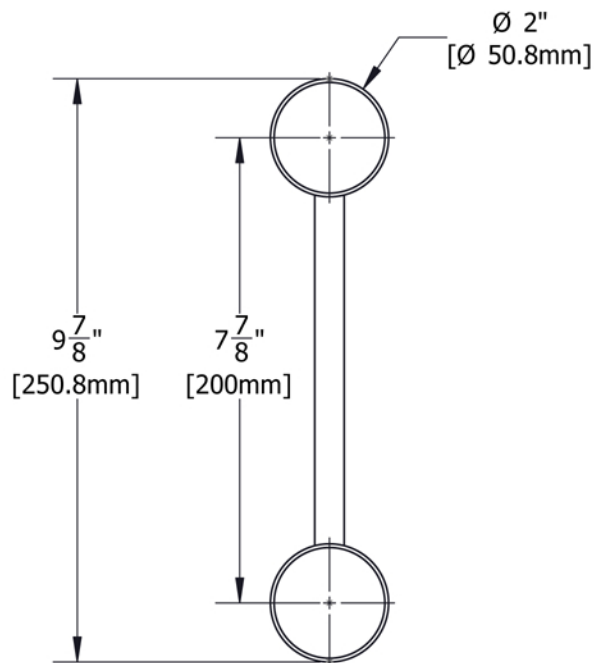

COLLAPSED VIEW

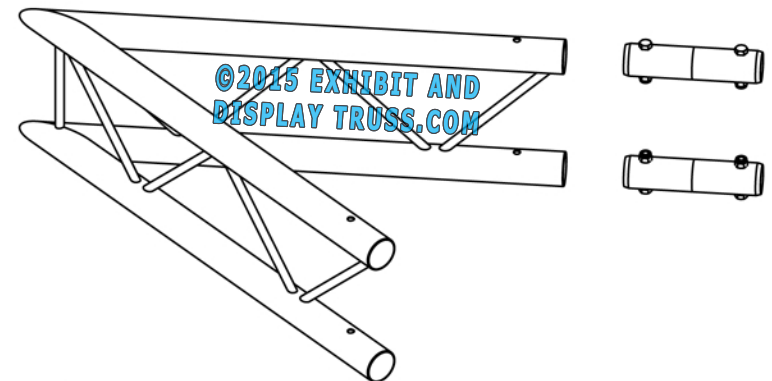

EXPLODED VIEW