

PART: EDT10-B2W45

10" Wide Aluminum Truss. 2" Chords with 1/2" Webs

©2015 EXHIBIT AND DISPLAY TRUSS.COM

2 Way 45° Junction

Truss Profile

10" Wide Box Truss
2"Ø Chords, 1/2"Ø Webs

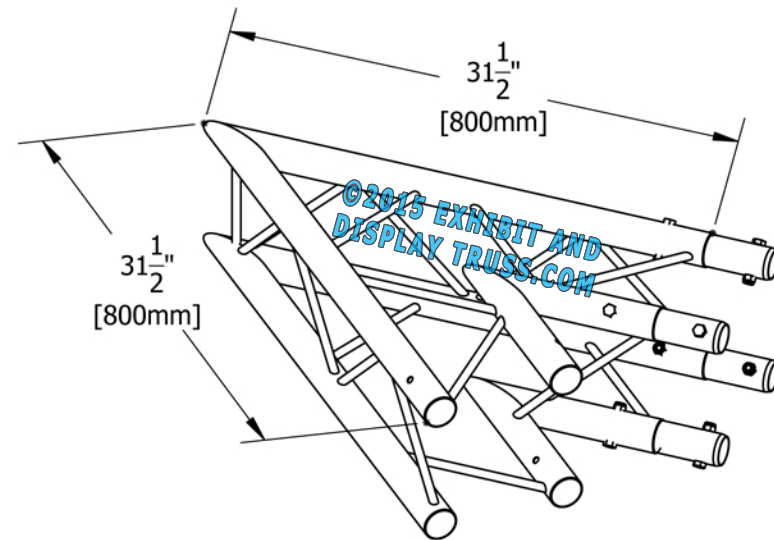
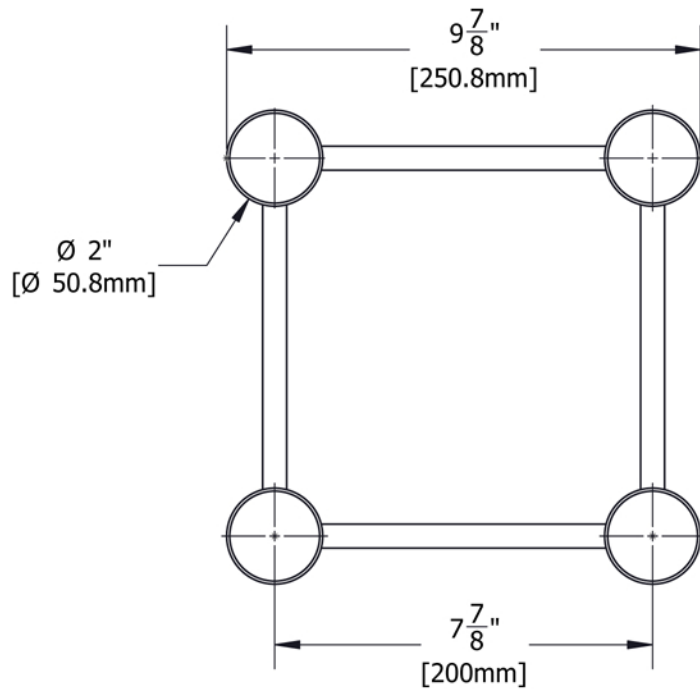

COLLAPSED VIEW

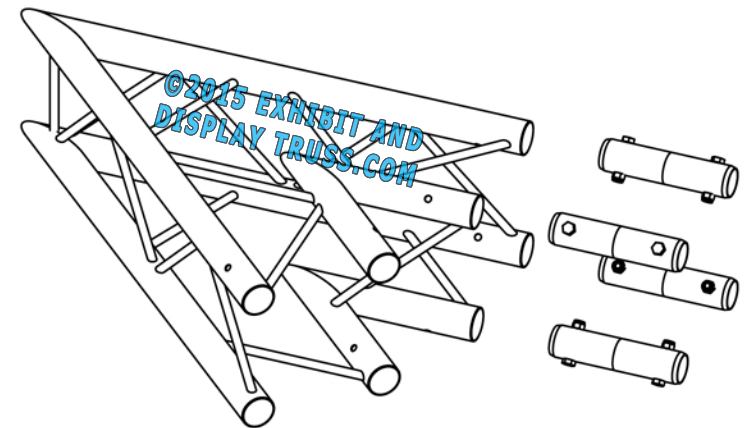

EXPLODED VIEW