

PART: EDT6-L2W45H

6" Wide Aluminum Truss. 1" Chords with 5/16" Webs

©2015 EXHIBIT AND DISPLAY TRUSS.COM

2 Way 45° Junction Horizontal

Truss Profile

6" Wide Ladder Truss
1"Ø Chords, 5/16"Ø Webs

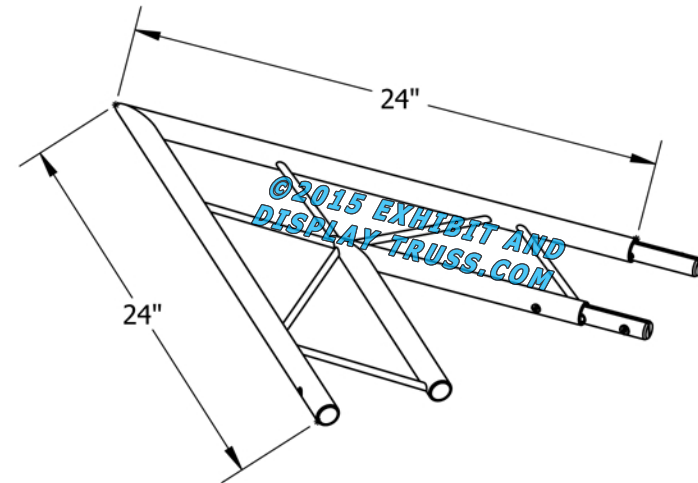
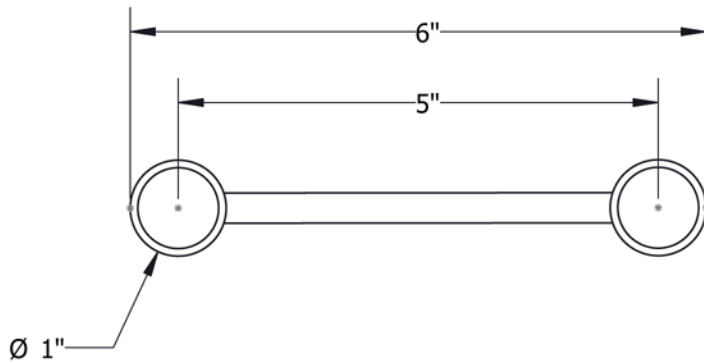

COLLAPSED VIEW

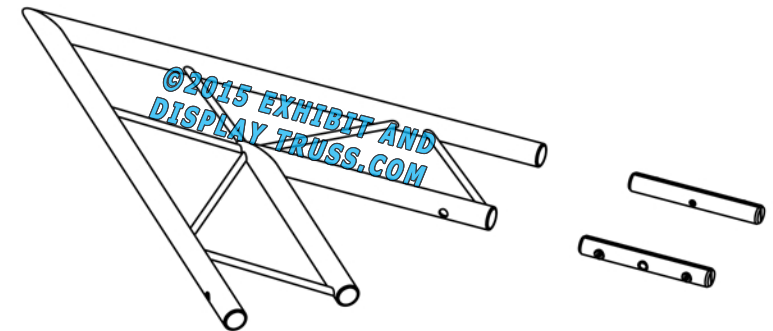

EXPLODED VIEW